

## Assembly Instructions Whirlpool Bath

# W20

(11v20) eng

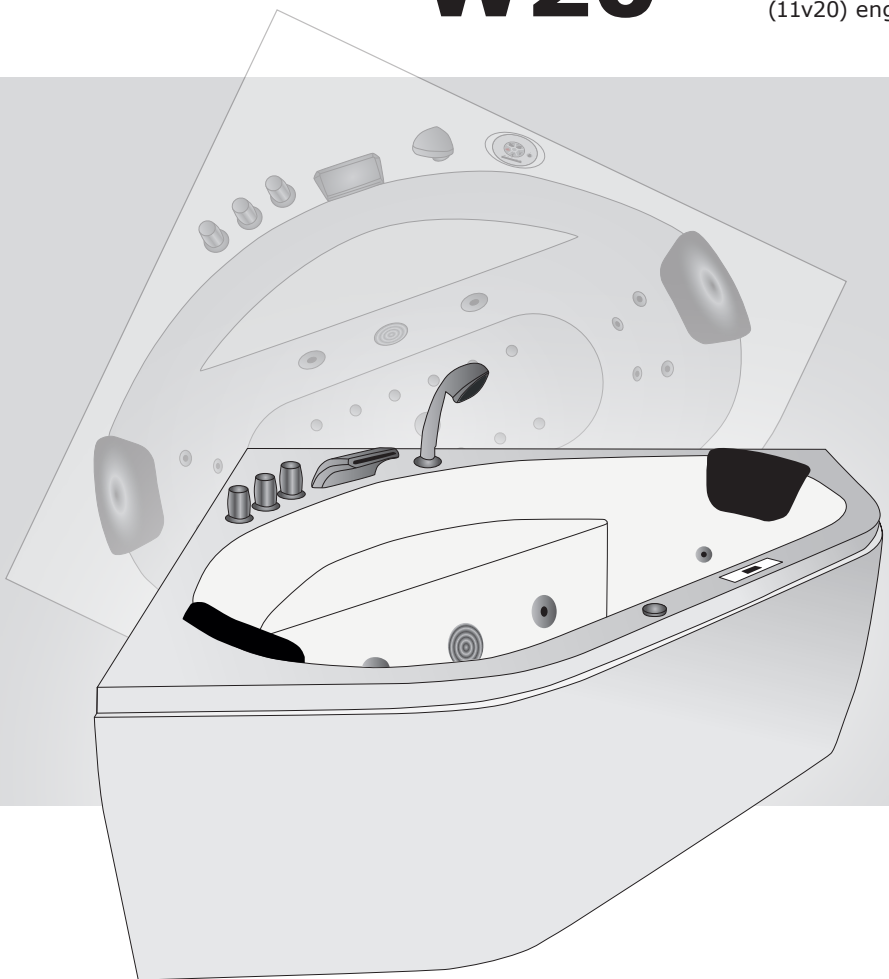

**Attention:** The pool should always be  
be done by two people!



## Foreword

Dear customer, we are pleased that you have chosen this product. Please observe all instructions before assembly and use and strictly follow the procedure below!

Please check the product for completeness first. If there is any damage, please send us a message with a short description and photos of the affected area. A responsible employee will contact you as soon as possible and find a solution together with you.

You have a 2-year legal warranty on all products.

## Important information

Please note: The product is designed exclusively for private use. Our products are subject to constant further development. This may result in changes to the design and the use of other components. We try to keep the following pages up to date. If you have any questions regarding the design, please contact us at +49 35795 - 179 600 or by e-mail at kundenservice@seniorbad.de. We are very grateful for any suggestions for improvement.

### **Please read the operating instructions carefully first!**

If you still have questions about the assembly, we will be happy to help you personally. Complaints resulting from incorrect installation or use are excluded from the warranty!

Seals, hand showers, shower hoses and castors are wearing parts, therefore a warranty period of 6 months applies here. The costs for replacement are not covered. Illuminants are completely excluded from the warranty.

- Installation and assembly work should only be carried out by a skilled worker.
- Make sure that the bathtub is properly earthed. We recommend that any electrical connections be made by trained professionals.
- The permissible water pressure should be approx. between 4 and 6 bar.
- From a hardness level of 10° (German hardness) we recommend the installation of a softening device.
- Complaints based on limescale deposits are excluded from the warranty!

## Sealing areas under/behind the bathtub

### Sealing is compulsory - silicone is not enough!

The areas behind and under the bathtub must be tiled. Sealant joints - like silicone joints - are not waterproofing, but only maintenance and beauty joints! Only the use of bathtub sealing tapes or e.g. sheet sealants comply with this DIN.

### Waterproofing according to DIN 18534

„This standard is therefore not only addressed to the waterproofing specialist, but also to those who are responsible for the overall planning and execution of the building and its components, because the effect and durability of the waterproofing depend on the coordinated planning of all those involved.“

*You as the installer are responsible for reliable waterproofing alongside the planner and tiler. „The waterproofing must fulfil its function for the intended service life with sufficient reliability.“*

Waterproofing must be planned so that it functions for the entire duration of use. In a domestic bathroom, this can be an average of 20 to 25 years. In practice, this means laying tiles or a membrane waterproofing under the bath is mandatory. Note that the sealing area at the transition from the floor to the wall must be at least 10 cm high.

### Please note:

- The pool must not be permanently installed. It must be ensured that it can be moved away from the wall for maintenance work.
- The pool should be connected by an approved tradesman.
- The pool should be installed by a professional in accordance with these installation instructions. The electrical connection for the pool must be made by a certified electrician. This person must also ensure sufficient earthing to prevent accidents and malfunctions.
- Please have an electrician check the function of the residual current circuit breaker regularly.
- The statics of the floor must ensure that it can withstand the total weight of the pool, including water and one person.
- The feet of the pool must stand on a firm, stable surface. The floor must be level.
- Any damage found during unpacking must be reported to the dealer immediately; it is best to take photos and send them to the dealer

## Technical data

### Outside dimensions of the pool

141 cm Length  
141 cm Wide  
55 cm High

### Inner dimensions of the pool

at the bottom 105 cm x 45 cm  
top 150 cm x 63 cm

### Hot and cold water connection

½ Inch max. 4 Bar  
Waist water HT 40mm

### Power connection

220-240 V  
50 Hz  
max. 4 A

### Heating

Massage pump air

Massage pump water

1500 W  
300 W  
750 W

### Max. water fill level

32 cm

## Tools for the construction

Tools are not included in the package.

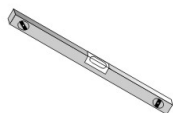

Spirit level

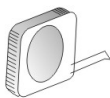

Measuring  
tape



Phillips / slotted  
screwdriver



Open-end spanner

# Bezeichnungen

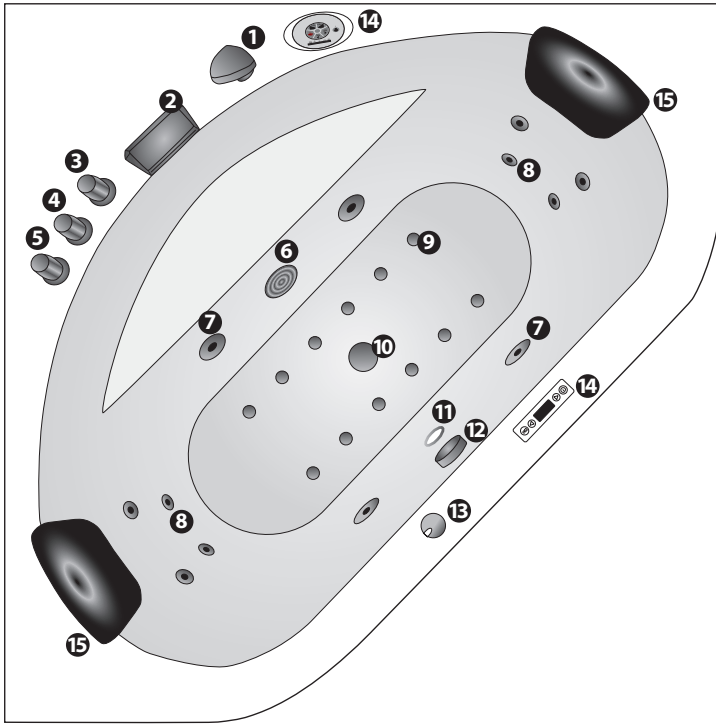

- |   |                              |    |                             |
|---|------------------------------|----|-----------------------------|
| 1 | Hand shower                  | 9  | Air jets (per version)      |
| 2 | Waterfall                    | 10 | Drain                       |
| 3 | Hand shower/waterfall switch | 11 | Colour light                |
| 4 | Cold water                   | 12 | Drain opener                |
| 5 | Hot water                    | 13 | Massage setting             |
| 6 | Water aspirator              | 14 | Control panel (per version) |
| 7 | Massage jets large           | 15 | Pillow                      |
| 8 | Massage jets small           |    |                             |

# Vorbereitung der Anschlüsse

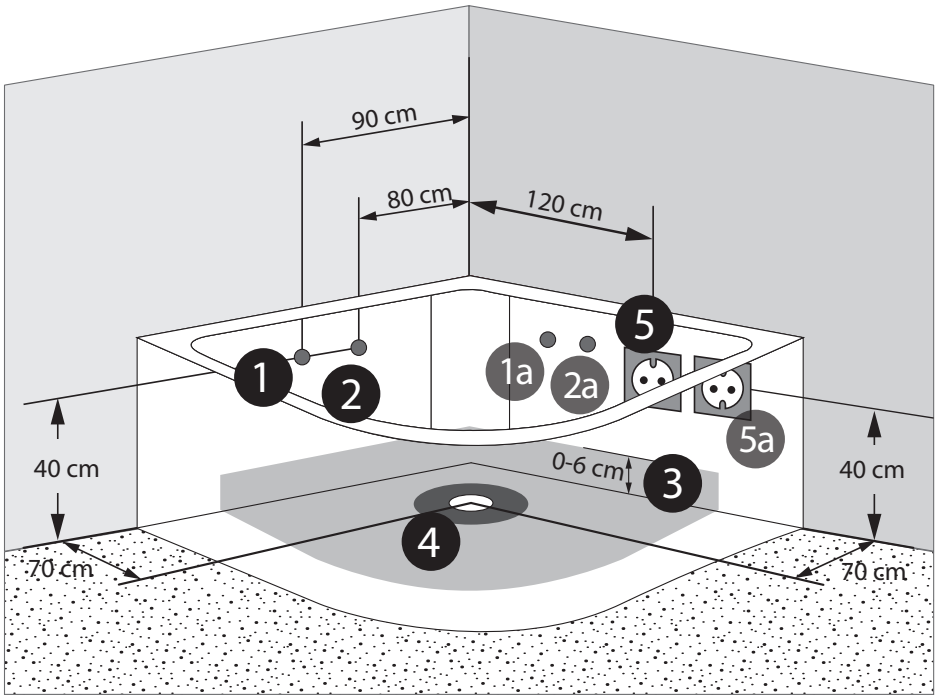

- ❶ Hot water 1/2 inch
- ❶a possible with hose extension
- ❷ Cold water 1/2 inch
- ❷a possible with hose extension
- ❸ Grey area = possible area for the drain pipes, in the wall area the drain can be up to a max. height of 6 cm from the centre of the hole.

Waste water via a flexible connection HT 40 supplied.

Connection possible without dismantling the skirt/panel.

- ❹ **ATTENTION:** leave the 15 cm  $\varnothing$  around the white siphon (dark grey area) under the drain free.
- ❺ Socket 230V 16A (or fixed socket)
- ❺a R-variant

## Alignment

In order for the pool to stand straight, it is necessary to align the pool exactly with the help of a spirit level. Each foot is individually adjustable, so you can compensate for small irregularities in the floor. Please make sure that all feet are touching the ground and that the weight is evenly distributed on the ground. **TO ADJUST THE FEET, THE APRON OF THE TUB MUST NOT BE REMOVED.** The front feet can be easily adjusted by tilting the tub slightly. All other feet can be easily reached from the side.

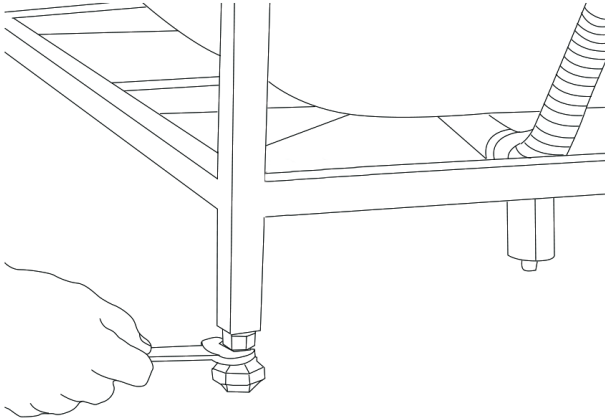

## Install drain pipes

The drain is in the floor, but the flexible drain hose can also be attached to a drain in the wall, but not higher than 6 cm so that the drain is still allowed. The flexible connection HT 40 used for this purpose is included in the delivery. It is not necessary to remove the apron for installation.

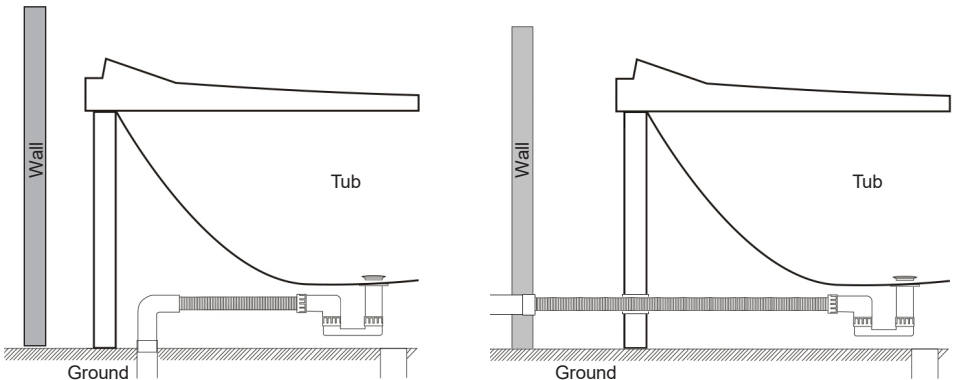

## Connecting the cold and hot water

After the drain has been installed, the water is now connected. The cold water connection is on the right and the hot water connection is on the left.

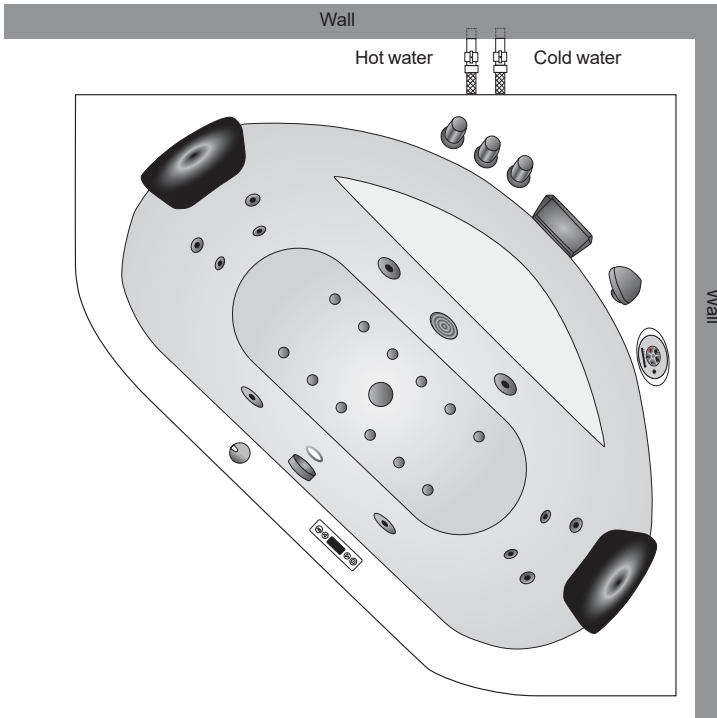

## Commissioning/leak test

For the leak test, please now connect the water and waste water with the hose connections. It is important that the tub continues to stand away from the wall so that you can still operate behind it. Before you put the pipe under water pressure, please note that it has only been pre-assembled by the factory to make it easier for you to set it up. It is absolutely necessary that you check all screw connections and tighten them if necessary. This applies to the nozzles and the clamps. Only when all this has been checked may you open the water inlet. Now test all the functions that have to do with water, one after the other. Check the hand shower and the function of the tap.

It is best to test this in pairs. One stands in front of or next to the bath, the other stands behind the bath and looks at the hose connection and the function that is currently being tested. If a screw connection is not properly tight, check whether the seal in the screw connection is properly seated and whether it is screwed tight enough. After the leak test, the electrical functions can now be tested. If the plug is plugged in, you can test the radio, whirlpool function, etc.



## Sealing

You can now draw a silicone joint between the tub and the wall to seal it.

## Pool control panel - A1420 R

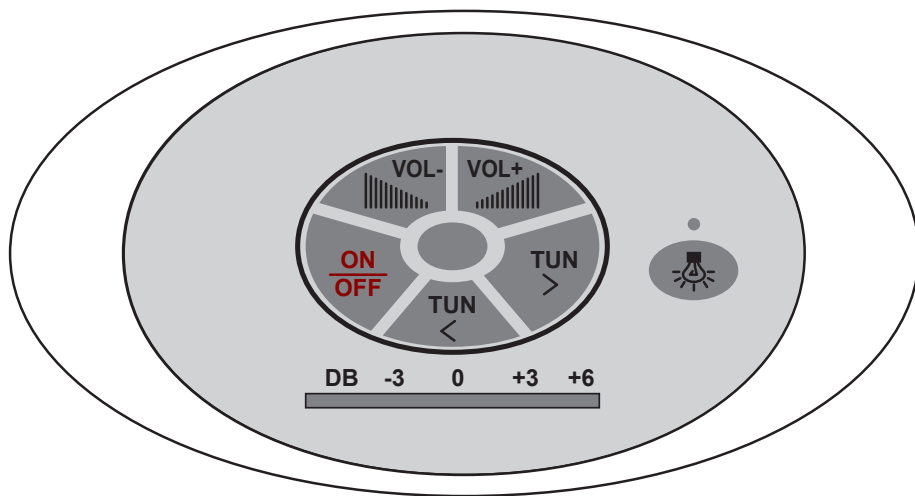

On/off switch



Volume +



Station search +



Volume -



Station search -



Underwater lamp

# Pool Bedienteil - A1420 H

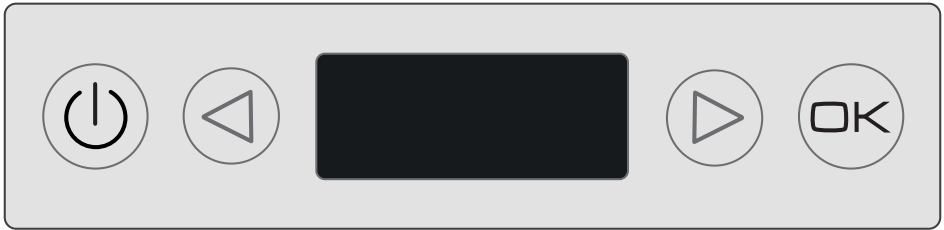

On/off switch



Confirmation switch





left



right

Press  for 2 seconds to start the control unit, press again to switch the control unit off again.

Press the left  and right  buttons to select the respective function and confirm with .



Light



Bluetooth



Air jets



Ozone



Heating



Water jets

Press the  key again to end the selected function.

If the control unit is not operated for more than 3 minutes, all keys are locked and „LOCK“ appears in the display. To unlock, press any key for 3 seconds, a sound indicates that the keys are unlocked again and the „LOCK“ disappears from the display.





Select light confirm with  and finish with .



Select ozone confirm with  and press  to end (the ozone switches off automatically after 10 minutes). No Bluetooth music playback with ozone.



Select air massage confirm with  and finish with .









Select water massage confirm with  and press  to end (the water pump only switches on when the set water level is reached).



Confirm Bluetooth selection with  (2s) The display shows „PAIR“. Switch on the Bluetooth function on your mobile phone. The pool appears on your display under the name JOYONWAY. The password is 2288. Now connect both devices.

Now you can play music stored on your mobile phone or content from streaming services (extra charge, not included in the scope of delivery) via the speakers of the pool.

Press  appears in the display. Use the left  and right buttons  to skip to the next or previous track. Press  to access the volume control „VOL“. Use the left  and right buttons  to set the desired volume.



Select heating confirm with  the temperature is set to 37° C by default.

To adjust the temperature, press  until °C flashes on the display. Now you can set the desired temperature with the left  and right buttons .

The temperature setting range is between 35° and 45° C.

## Maintenance and cleaning of the pool

1. Clean the pool with a mild liquid detergent and a soft cloth. Caution: Never use acetone, cleaning agents containing ammonia or coarse-grained scouring agents!
2. Clear the pool drain regularly of hair and the like to prevent clogging.
3. Use an acrylic care product for the tub and the panel to protect the surface from scratches.
4. Small scratches can be polished with toothpaste and a soft cloth, for example.
5. Before using the whirlpool system for the first time, it should be rinsed through with disinfectant. Afterwards, it is sufficient to repeat the disinfection after approx. 5 baths. Disinfection should also be carried out if the whirlpool system is not used for a longer period of time.

## Warranty and service

You receive a 2-year warranty for our products. A warranty period of 6 months applies to wearing parts such as seals, hand showers and shower hoses. The costs for replacement are not covered. Spare parts can be ordered from our customer service.

E-mail: **kundenservice@seniorbad.de**

Online shop: **www.seniorbad.de**

Telephone: **+49 35795 - 179 600**

Fax: **+49 35795 - 179 699**

Defects that can be traced back to calciferous or iron-rich water are excluded from the warranty. Please describe the spare part exactly and state the exact pool type (e.g. W20). We are always open to your comments and suggestions.

## Note

Each pool is assembled, connected, tested and repacked at the factory for testing purposes. As our products are subjected to several checks during manufacture, small amounts of residual water may be present in parts of the product.

## Recycling

The disposal of the product's electronics is governed by the Waste Electrical and Electronic Equipment Act. The „old device“ must then be taken to an appropriate collection point.

We recommend that you remove the control unit, the lighting unit and the display and take these parts to the electrical/electronic collection point. The remaining large „residue“ can be treated as usual (local variant - such as bulky waste collection ...).

